



## Features & Benefits

1. High performance and reputable brand LED chips and driver
2. Clear tempered glass decrease risk of lamp breaking for strong industrial applications
3. Optimized aluminum alloy housing design for superior thermal management
4. Instant light up with no warm up time
5. No cool down needed before restart
6. High mechanical impact resistance and ingress protection rating
7. Symmetric and asymmetric light distribution

## Options

1. Housing color and glass color
2. Length wire and special plug
3. Dimming 0-10V, 1-10V, DALI

Follow us





### Key Features

Straight fin structure with pillars, greatest heat dissipation

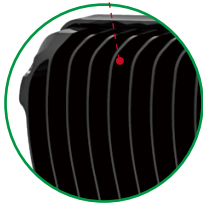

Rubber Cushion, dustproof



304 stainless steel screw, corrosion resistant treatment, suitable for coastal area

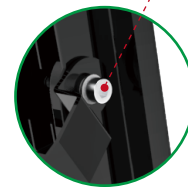

Hem corner, strengthen stability

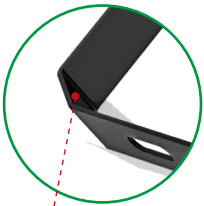

Galvanized bracket, corrosion resistant

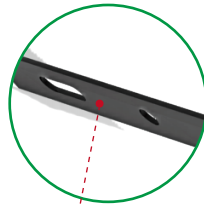

Breather Valve, balance the internal and external pressure and humidity

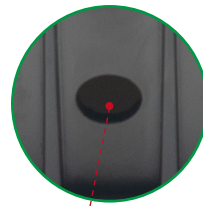



### Photometry

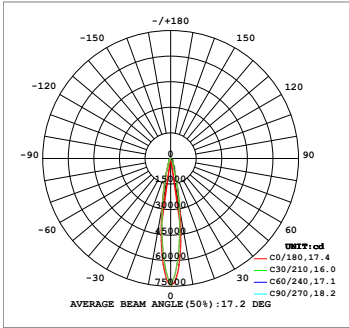

15°

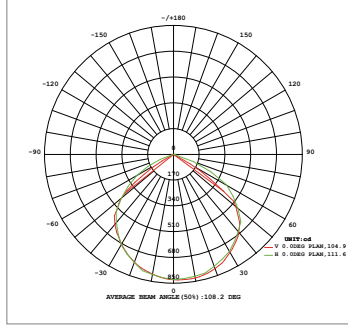

30°

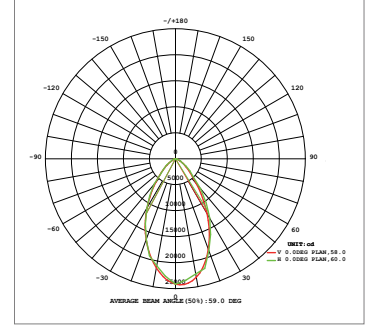

60°

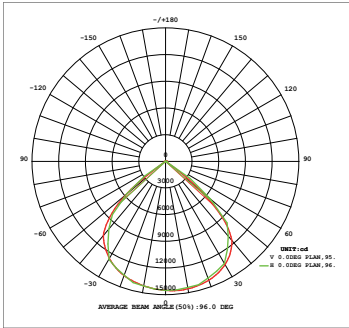

90°

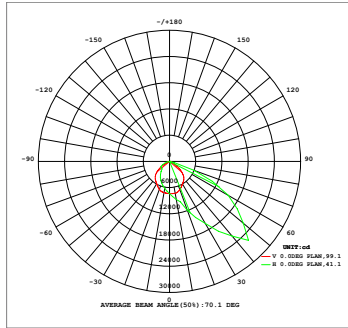

150\*50°

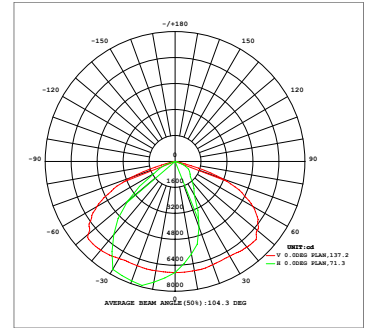

150\*70°

### Dimension Drawing

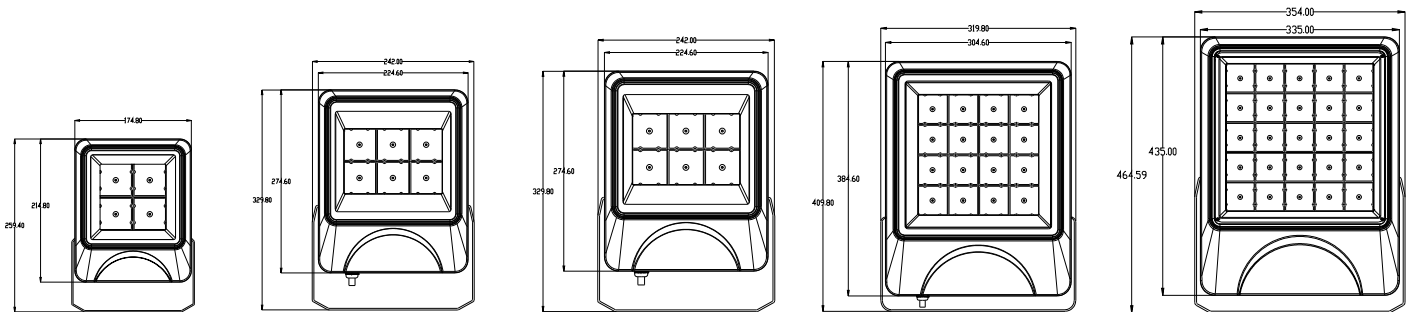



### Installation

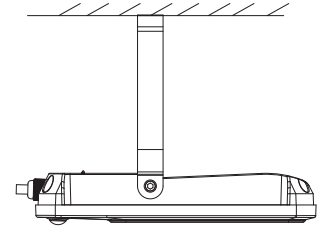
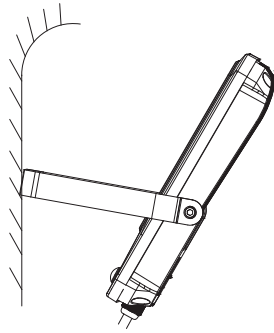
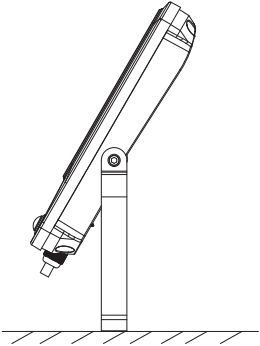

### Specification

Model	ISL-XTGD-030G	ISL-XTGD-050G	ISL-XTGD-0100G	ISL-XTGD-0150G	ISL-XTGD-0200G
Rated Power	30W	50W	100W	150W	200W
Input Voltage	AC100-277V				
Chip	Epistar / Bridgelux				
Driver	ZH / Sosen / Meanwell				
CRI	80				
LED QTY	48 pcs	72 pcs	108 pcs	192 pcs	300 pcs
Luminous Efficacy	120-130lm/W				
IP Rating	IP66				
Operation Temperature	-20~+50 °C				
Beam Angle	120°				
Warranty	3 / 5 years				
Dimension	215*175*47mm	275*225*48mm	325*275*53mm	385*305*58mm	465*354*65mm

## Package

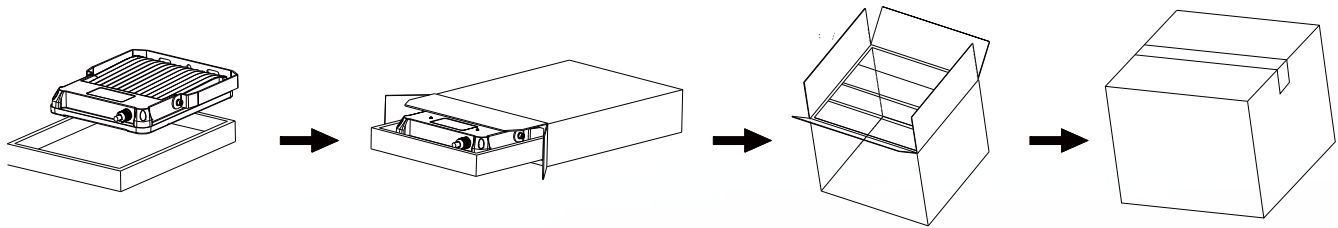

Model	Carton Size	N.W	G.W	QTY
ISL-XTGD-30W	620*330*250mm	22.5KG	23.1KG	15PCS/CTN
ISL-XTGD-50W	525*37*315mm	21.5KG	22.7KG	10PCS/CTN
ISL-XTGD-100W	450*325*383mm	20.25KG	21KG	5PCS/CTN
ISL-XTGD-150W	372*362*448mm	20.8KG	21.3KG	4PCS/CTN
ISL-XTGD-200W	388*290*490mm	21.3KG	21.8KG	3PCS/CTN

Telephone: +86-0755-29815402

Email: [info@ishinelux.com](mailto:info@ishinelux.com)

Tel: 0755-29875402 Fax: 0755-29875719

Web: [www.ishinelux.com](http://www.ishinelux.com)/ALL right reserved.specifications are subject to change without prior notice.

Add: 7F,building AB,HongLianying Tech. Park, Longhua District, shenzhen, Guangdong 518000, China